

## Spacers

In accordance to IEC 641-1 Type B 3.1

### Features:

- Precompressed pressboard, even fibre orientation, hard and dimensionally stable
- 100% sulphate wood pulp
- Natural - coloured
- High purity and mechanical strength
- Low shrinkage and compressibility
- Good compatibility with liquid dielectrics
- **Insulation class A** (105 °C) in accordance to VDE 0530 Part 1

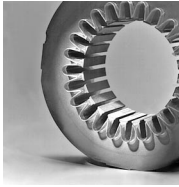
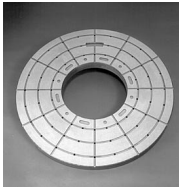
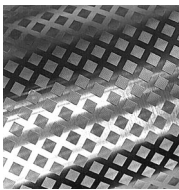
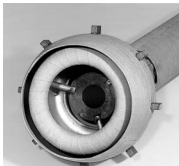
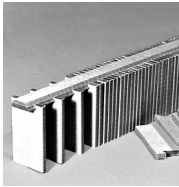
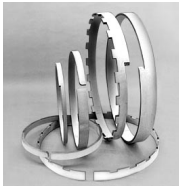
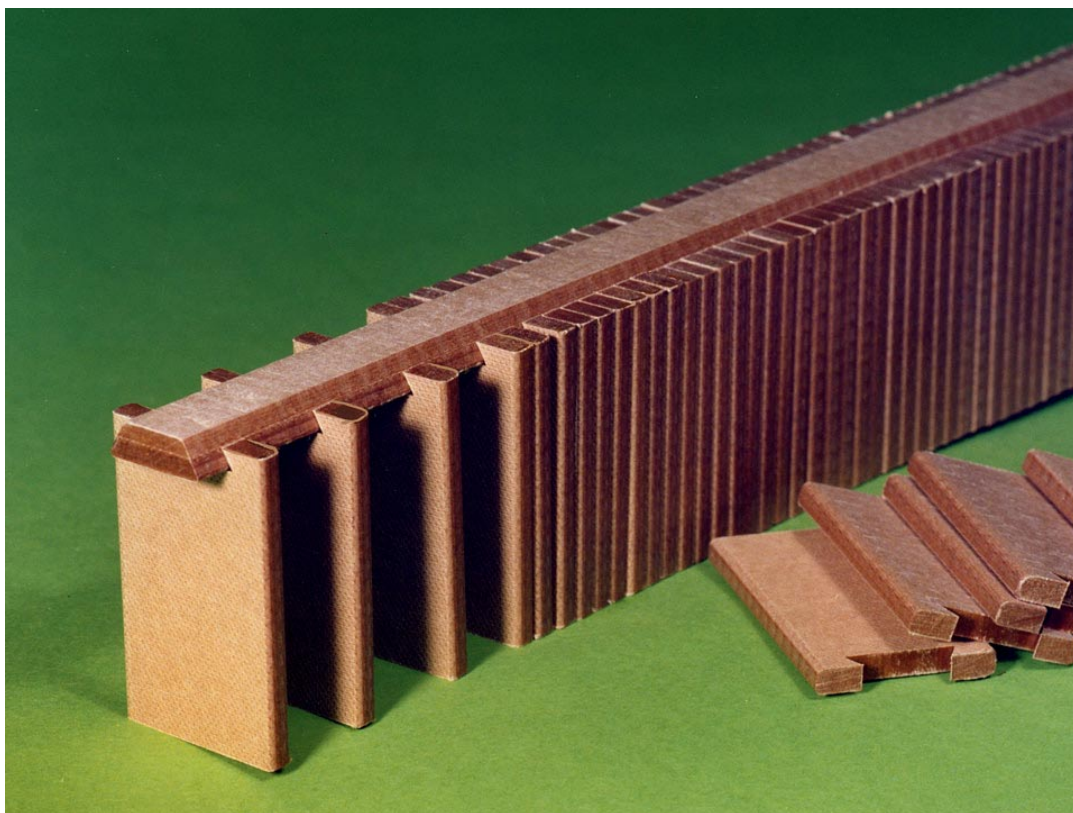

# Technical Data

## Spacers

In accordance to IEC 641-1 Type B 3.1

### Sizes and tolerances:

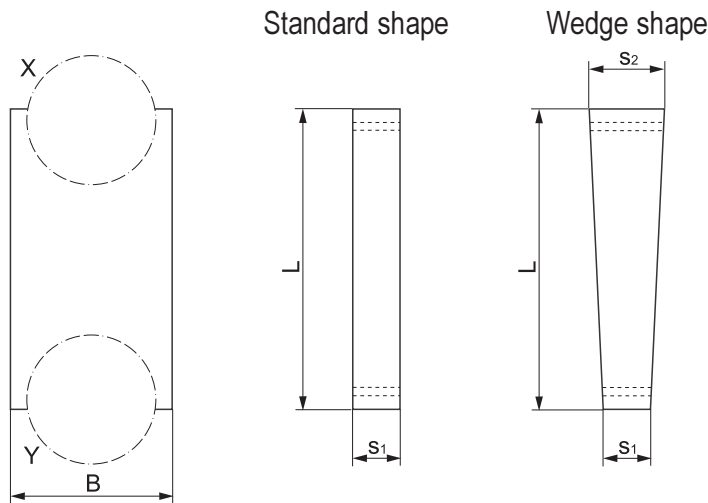

For  $s = 1 - 3$  mm:  
punched or milled

For  $s > 3 - 8$  mm:  
milled

For  $s > 8$  mm:  
made of ELBOARD HDLP

### Detail X, Y

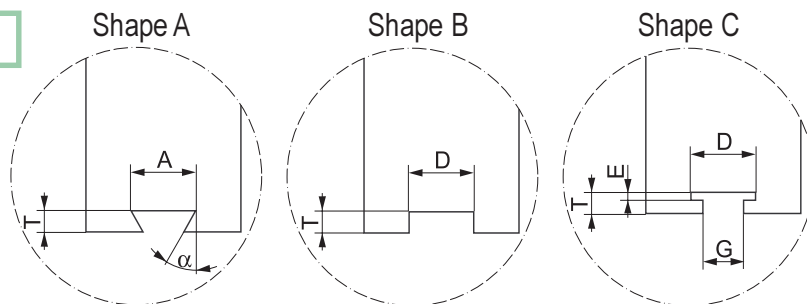

### Designation:

|            | L<br>mm   | B<br>mm   | s <sub>1</sub><br>mm | s <sub>2</sub><br>mm | $\alpha$<br>° | A<br>mm      | D<br>mm      | E<br>mm    | G<br>mm    | T<br>mm    |
|------------|-----------|-----------|----------------------|----------------------|---------------|--------------|--------------|------------|------------|------------|
| Sizes      | 30 - 150  | 25 - 60   | 1 - 12               | 1 - 12               | 30            | 16 - 25      | 16 - 25      | 0.5 - 3    | 16 - 25    | free       |
| Tolerances | $\pm 0.3$ | $\pm 0.3$ | $\pm 0.1$            | $\pm 0.1$            | $\pm 1$       | +0.1<br>+0.4 | +0.1<br>+0.4 | +0.3<br>-0 | +0.4<br>-0 | +0.4<br>-0 |

### Further dimensions on request

The above values, which have been determined by careful tests, provide only general information. PUCARO has implemented several programs to assure the highest quality and reliability of this product. However, no responsibility is assumed for its use.